

IT7000 - High Performance HMI

High-end functionality and connectivity;
easy integration with any machine control system

- 7", 10" & 15" display sizes
- IP65 rating (front side)
- Built-in Ethernet and serial ports



C22.2 No.14-13

The IT7000 – flexible human machine interface



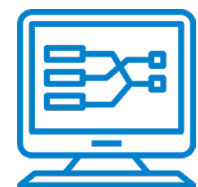
Functionality

- Supports **VNC** remote access through mobile devices
- Trend chart & oscilloscope for continuous wave sampling
- **Multi-language** capability



Programming

- User friendly InoTouchPad PC configuration software (Windows 10 compatible)
- **Javascript** for creation of plug-ins and dedicated communication protocols, & access to external databases
- Canvas control for free graphic drawing



Graphical capabilities

- Up to 1,024 x 768 resolution (16 M colours)
- Customizable user interface (via CSS)



Data management

- USB & micro SD cards for easy data management
- **Real-time clock**
- Maintains comprehensive historical data records



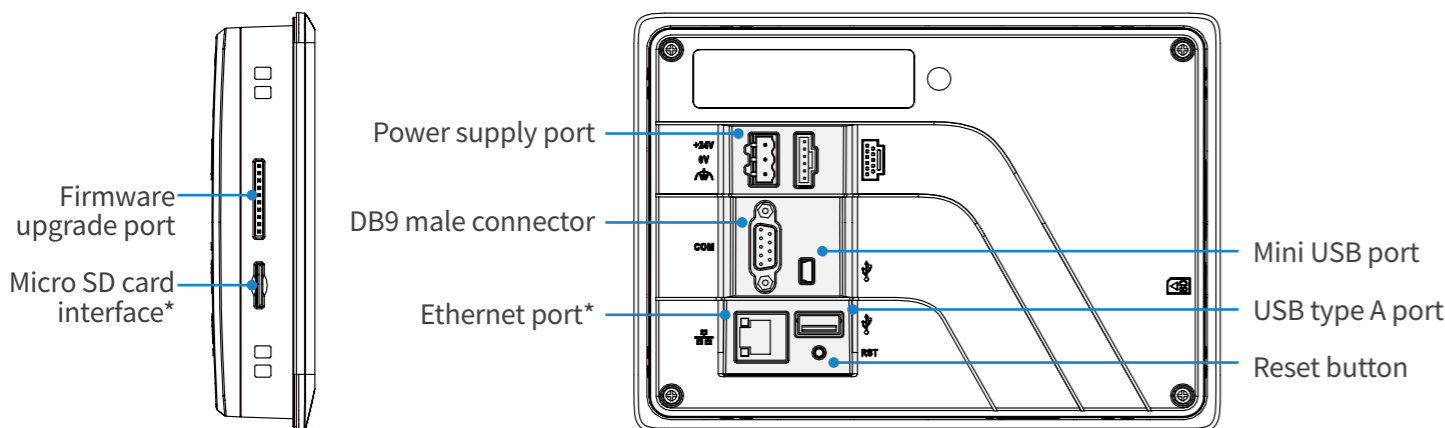
Flexible connectivity

- Serial port and/or Ethernet stand-alone and multi-device networking
- Supports products from a wide range of 3rd party manufacturers
- Support for **OPC UA** and **Modbus RTU/TCP** protocols
- IIoT ready: **MQTT** implementation, seamlessly connects to any server

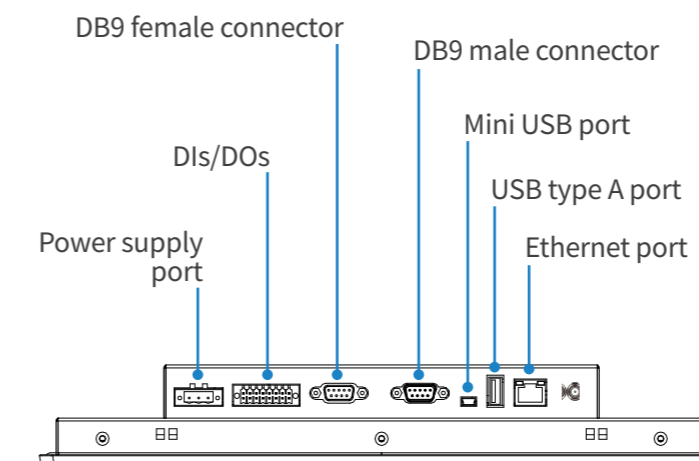


*Image shown is the 15" model

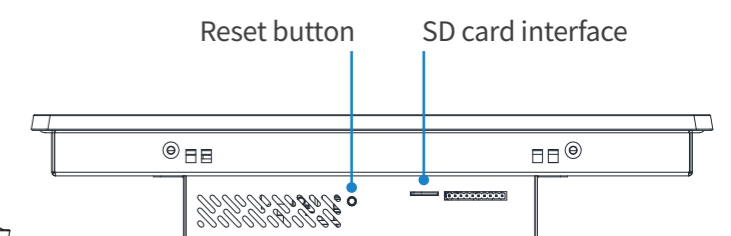
IT7070T, IT7070E & IT7100E terminals



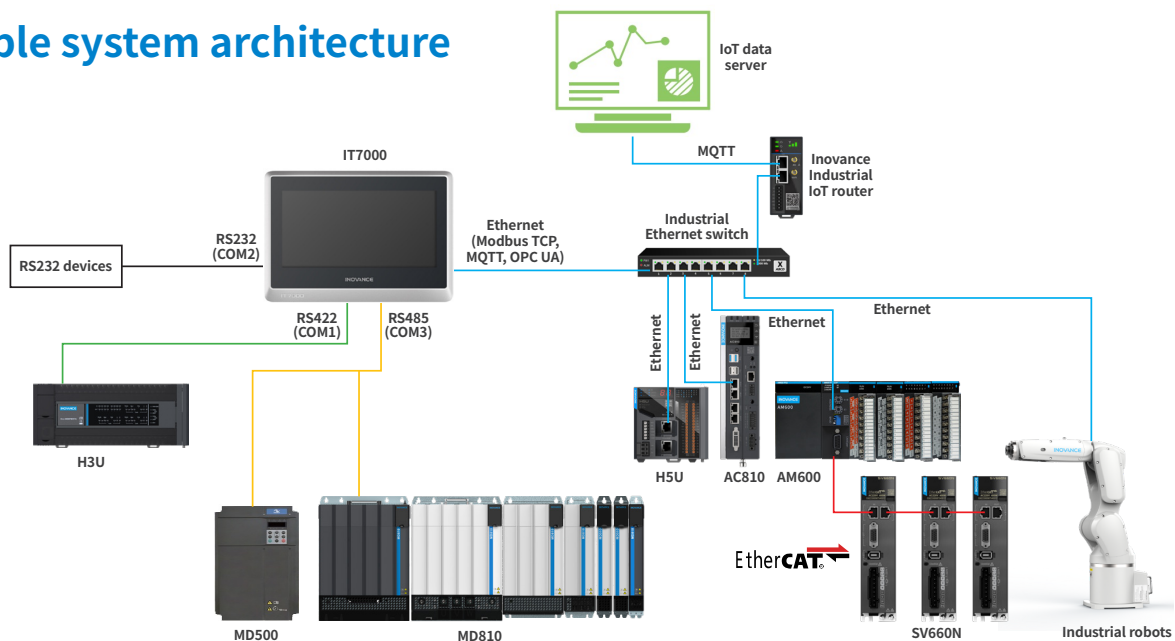
* Not available in IT7070T







IT7150E terminals



Example system architecture



Specifications

Model	IT7070T	IT7070E	IT7100E	IT7150E
				
Display size	7.0"	7.0"	10.1"	15.0"
Dimensions L x W x D (mm)	200 x 146 x 35	200 x 146 x 35	271 x 146 x 36	368 x 295 x 53
Resolution	800 x 400	800 x 480	1,024 x 600	1,024 x 768
CPU	Cortex A8 600 MHz	Cortex A8 600 MHz	Cortex A8 1 GHz	Cortex A8 1 GHz
RTC	✓	✓	✓	✓
DRAM	128 MB	128 MB	256 MB DDR3	256 MB DDR3
Flash	128 MB	128 MB	256 MB	256 MB
Brightness (cd/m ²)	350	350	350	300
Display colour	24-bit true colour			
Backlight	LED			
Backlight service life	35,000 hrs	35,000 hrs	30,000 hrs	50,000 hrs
SD card interface	x	✓	✓	✓
USB drive interface	USB 2.0 interface x 1			
USB download interface	Mini USB interface x 1			
Ethernet interface	x	✓	✓	✓
Serial port	COM1 (RS422/RS485) COM2 (RS232)	COM1 (RS422/RS485) COM2 (RS232) COM3 (RS485)		
Input voltage	24 VDC ± 20%			
Rated input current	250 mA	250 mA	300 mA	800 mA
Battery	Lithium battery, 3.0 V, 225 mAh			
Panel IP rating	Front panel IP65, back cover IP20			
Product code	01450030	01450039	01450036	01450028

For more information, please contact our local offices.

International Offices

● **Germany-Stuttgart**
Tel: +49 (0) 7144 8990
sales.de@inovance.eu

● **Italy-Milano**
Tel: +39 (0) 2268 22318
sales.it@inovance.eu

● **France-Bordeaux**
Tel: +33 (0) 5594 01050
sales.fr@inovance.eu

● **Spain-Barcelona**
Tel: +34 93 504 94 48
sales.es@inovance.eu

● **Turkey-Istanbul**
Tel: +90 (216) 706 17 89
sales.tr@inovance.eu

● **South Korea-Seoul**
Tel: +82 2 3489 8850
sales.kr@inovance.eu

● **India**
Head Office Chennai Tel: +91 (0) 44 4380 0201

Ahmedabad Tel: +91 (0) 79 4003 4274

Mumbai Tel: +91 (0) 22 4971 5883

New Delhi Tel: +91 (0) 11 4165 4524

Sales Network in Kolkata, Bengaluru, Pune, Coimbatore, Hyderabad, Vadodara, Jaipur
info@inovance.ind.in

Hong Kong SAR
International Export Office
Tel: +852 2751 6080
info@inovance.eu

For other country distributors, contact the Hong Kong office.

Inovance Technology Companies
Shenzhen Inovance Technology Co. Ltd.
Suzhou Inovance Technology Co. Ltd.

INOVANCE
www.inovance.eu